



**LIFE+11 NAT/IT/000135 - FAGUS
FORESTS OF THE APENNINES: GOOD PRACTICES TO
CONIUGATE USE AND SUSTAINABILITY**



Azione E5 – Courses for local harvesters

Deliverable E5.1: Training material for local harvesters

Beneficiario responsabile



UNIVERSITÀ
DEGLI STUDI DELLA
Tuscia

DIBAF

Dipartimento per la Innovazione nei sistemi
Biologici, Agroalimentari e Forestali

ABBIGLIAMENTO DELL'OPERATORE

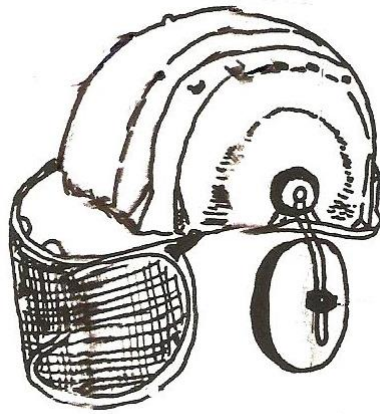

Elmetto di sicurezza con visiera e cuffie integrate.

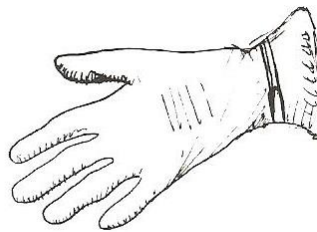

Guanti robusti.



Scarponi con punta in acciaio e suola antisdrucciolo e tessuto anti taglio.

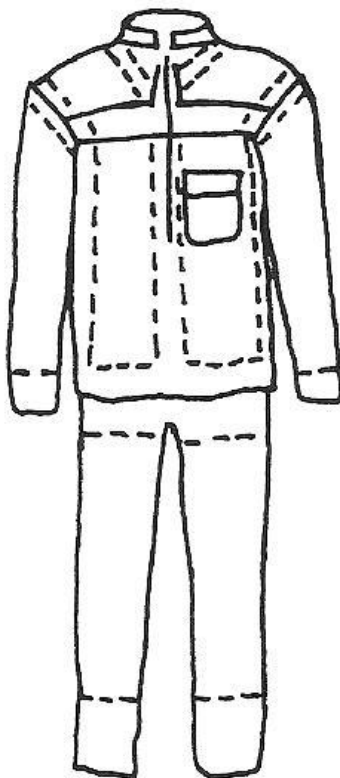

Abbigliamento robusto con inserti in materiale anti taglio (anche solo nei pantaloni).

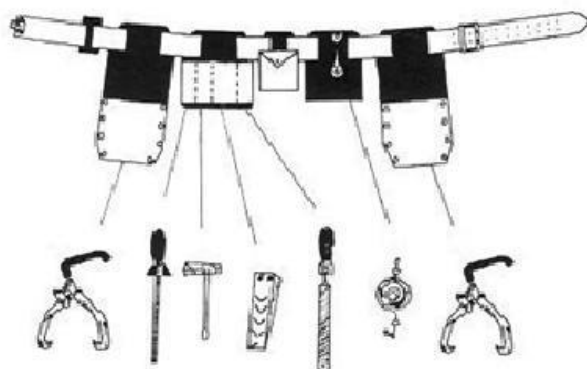

Cinturone con due tasche per le pinze, una porta lime, aggancio cordella metrica auto avvolgente e bustina del pronto soccorso.

ATTREZZATURA DELL'OPERATORE



Per lavori particolari motosega di media potenza con barra carving e catena antirimbalo. Per abbattere ed allestire, motosega di media potenza.

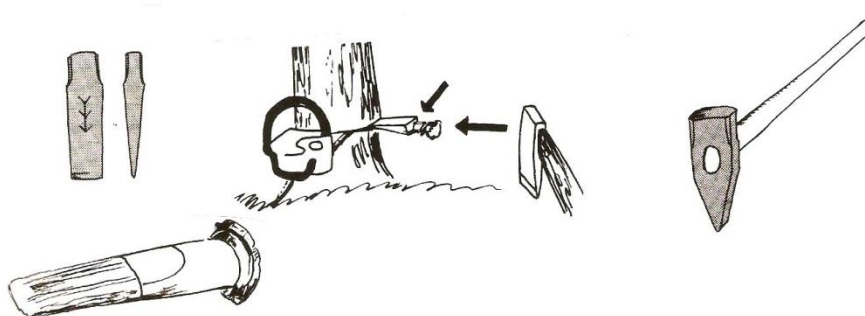

Cunei da 19 e 26 cm di lunghezza.

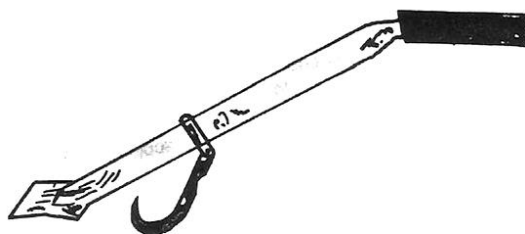

Leva di abbattimento, con gancio gira tronchi, lunga 80 cm.

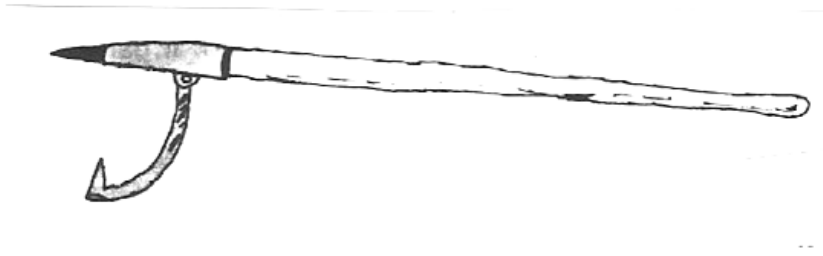

Leva gira tronchi lunga 115 cm.



Zappino lungo 110 cm.

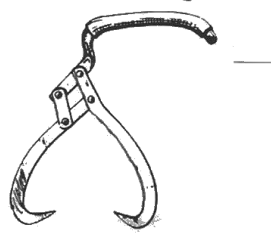

Pinze lunghe 21 cm.



Tanica a doppio corpo per miscela e olio catena.



Cordella auto avvolgente con nastro lungo 20 m.

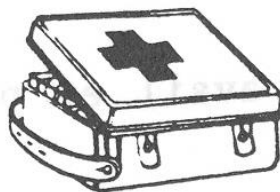

Cassetta di pronto soccorso.

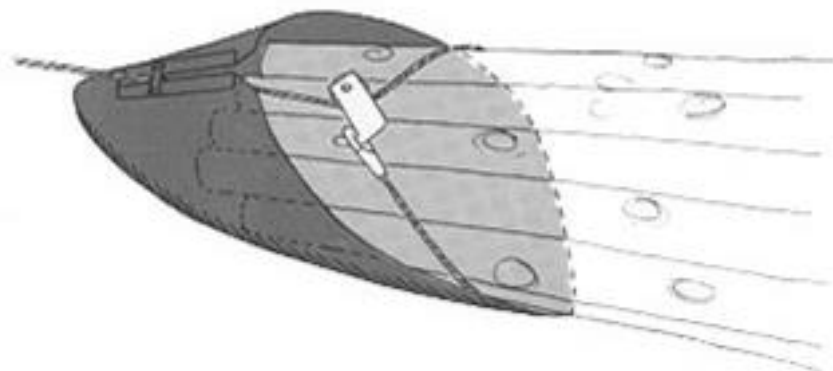

Scudo per il concentramento dei tronchi.

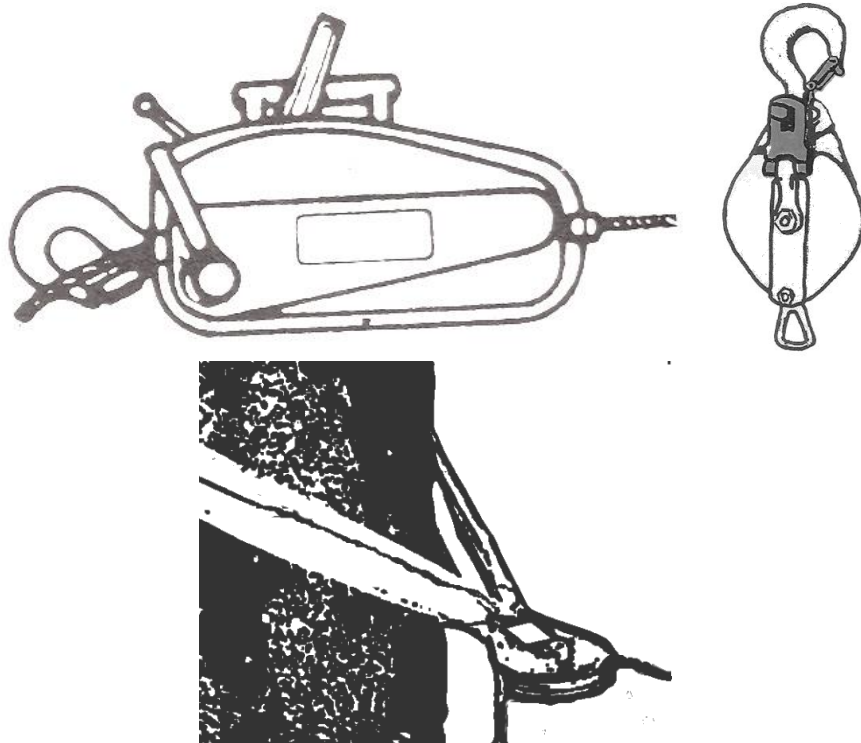

Tirfor da 1600 kg con carrucola apribile da 2000 kg e due cinghie tubolari lunghe 2,5-3 m da 2000 kg.

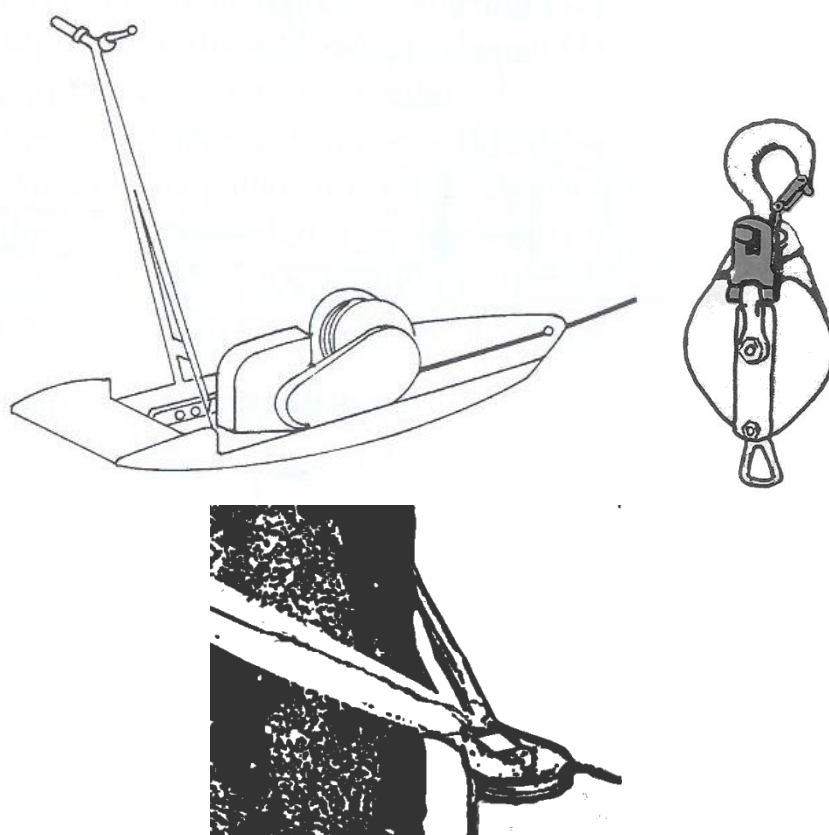

KMF con 100 m di fune da 6-8mm, due cinghie tubolari da 1000 kg lunghe 2,5-3 m e una carrucola apribile da 1000 kg.

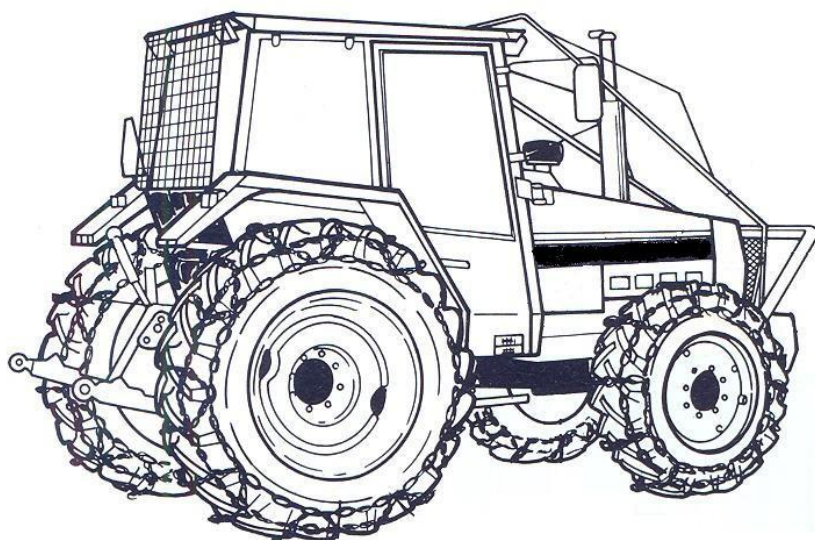

Trattore agricolo da 50-70 kW di potenza con sollevatore idraulico e presa di potenza.

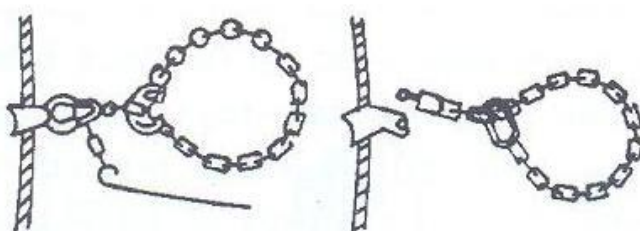
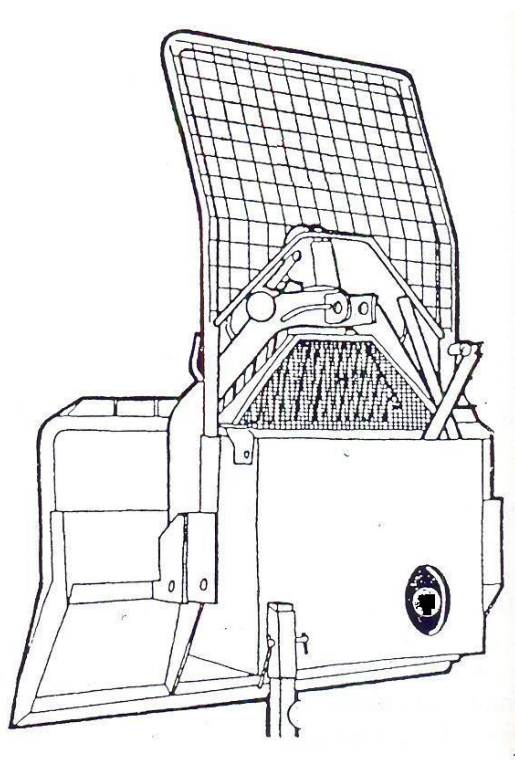

Verricello forestale con scudo e bocca di esbosco da 3500-4000 kg con fune da 10 mm e 3 ganci scorrevoli per altrettante catene.

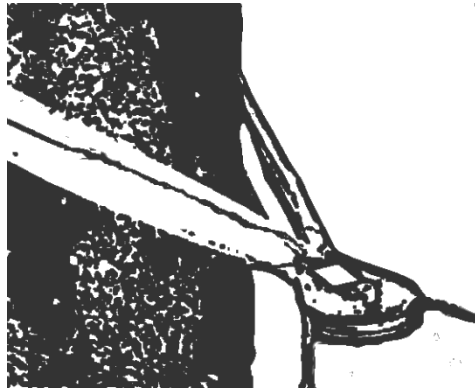
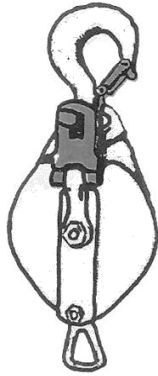

Una carrucola apribile e una cinghia tubolare da 3000 kg, lunga 2,5-3 m.



Rimorchio forestale a doppio asse, trazionato con caricatore.

ATTREZZATURA DELL'OPERATORE ADDETTO AI LAVORI SU FUNE OLTRE I 2 M DI ALTEZZA DAL SUOLO



Imbrago basso idoneo per i lavori in pianta.



Elmetto di protezione da arrampicata completo di cuffie e visiera.



Bloccante per piede destro o sinistro.



Bloccante con camma.



Discensore autofrenante bloccante.



Sistema di frizione per lavorare su corda, composto di cordino OP lungo 80 cm, carrucola a tre punti di ancoraggio e 2 moschettoni OK.



Corda da lavoro statica da 13 mm da 24 trefoli.



Corda di sicurezza semistatica da 11 mm da 24 trefoli.

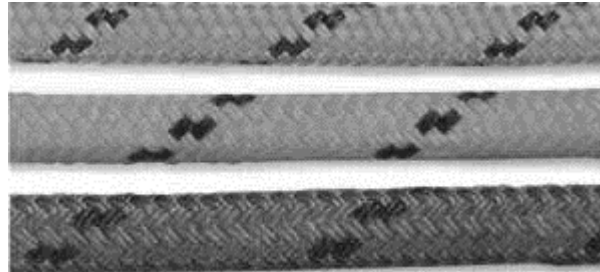

Corda da abbattimento da minimo 14,5 mm carico di rottura 62kN.

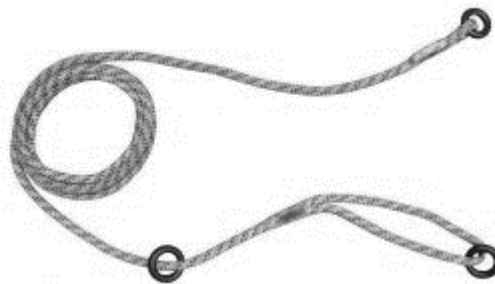

Ancoraggio mobile.



Cordino per prusik.



Ramponi da arboricoltore punta media con cinghie.



Carrucola da abbattimento carico di rottura di 100 kN.



2 Carrucole doppie mini twin carico di rottura min 23 kN.



Salvacambio ad anelli carico di rottura min 23 KN.



Sagolino 60m.



3 pesi da lancio per sagolino.



6 moschettoni tripla sicurezza carico di rottura min 23Kn.



2 moschettoni in acciaio doppia sicurezza carico di rottura min 50Kn.



3 Fettucce ad anello ad alto carico.

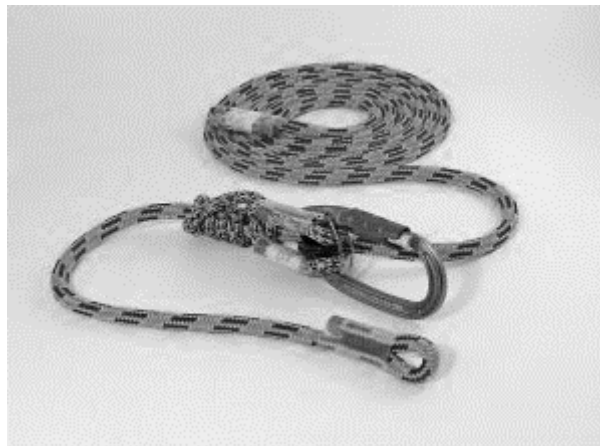

Longe di posizionamento completa lunga 4 m.

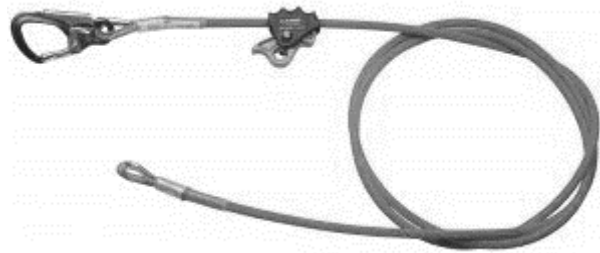

Longe antitaglio completa lunga 4m.



Barra e catena carving per motosega.



Seghetto professionale.



Seghetto professionale telescopico



Longe motosega.